

AudioControl®

Making Good Sound Great™



The Director™ Model M6400 and M6800

16 CHANNEL MULTI-ZONE NETWORK MATRIX AMPLIFIERS

Important Safety Instructions

1. Read these instructions.
2. Keep these instructions.
3. Heed all warnings.
4. Follow all instructions.
5. Do not use this apparatus near water.
6. Clean only with a dry cloth.
7. Do not block any ventilation openings. Install in accordance with the manufacturer's instructions.
8. Do not install near any heat sources such as radiators, heat registers, stoves, or other apparatus (including amplifiers) that produce heat.
9. Protect the power cord from being walked on or pinched particularly at plugs, convenience receptacles, and the point where they exit from the apparatus.
10. Only use attachments/accessories specified by the manufacturer.
11. Unplug this apparatus during lightning storms or when unused for long periods of time.
12. Refer all servicing to qualified service personnel. Servicing is required when the apparatus has been damaged in any way, such as power-supply cord or plug is damaged, liquid has been spilled or objects have fallen into the apparatus, the apparatus has been exposed to rain or moisture, does not operate normally, or has been dropped.
13. This apparatus shall not be exposed to dripping or splashing, and no object filled with liquids, such as vases or glasses, shall be placed on the apparatus.



The lightning flash with arrowhead symbol within an equilateral triangle is intended to alert the user to the presence of uninsulated "dangerous voltage" within the product's enclosure, that may be of sufficient magnitude to constitute a risk of electric shock to persons.



The exclamation point within an equilateral triangle is intended to alert the user of the presence of important operating and maintenance (servicing) instructions in the literature accompanying the appliance.



Caution: to reduce the risk of electric shock, do not remove the top cover. There are no user-serviceable parts inside. Refer servicing to qualified personnel.

This equipment has been tested and found to comply with the limits for a Class B digital device, pursuant to part 15 of the FCC Rules.

These limits are designed to provide reasonable protection against harmful interference in a residential installation.

This equipment generates, uses, and can radiate radio frequency energy and, if not installed and used in accordance with the instructions, may cause harmful interference to radio communications. However, there is no guarantee that interference will not occur in a particular installation.

If this equipment does cause harmful interference to radio or television reception, which can be determined by turning the equipment off and on, the user is encouraged to try to correct the interference by one or more of the following measures:

- Reorient or relocate the receiving antenna.
- Increase the separation between the equipment and the receiver.
- Connect the equipment into an outlet on a circuit different from that to which the receiver is connected.
- Consult the dealer or an experienced radio/TV technician for help.

CAUTION: Changes or modifications to this device not expressly approved by AudioControl Inc. could void the user's authority to operate the equipment under FCC rules.



Recycling notice: If the time comes and this apparatus has fulfilled its destiny, do not throw it out into the trash. It has to be carefully recycled for the good of mankind, by a facility specially equipped for the safe recycling of electronic apparatus. Please contact your local or state recycling leaders for assistance in locating a suitable nearby recycling facility. Or, contact us and we might be able to repair it for you.

Table of Contents

Important Safety Instructions	2
Introduction	4
Congratulations!	4
Features	5
Complimentary Features	6
Quick View	7
Getting Started	8
Installation Examples	8
Front Panel Features	12
Rear Panel Features	14
Speaker Connections	17
12 Volt Trigger Ins and Outs	19
Ventilation	21
Internet Connectivity and Control	22
Acoustics	33
Equalization	34
Advanced Discussions	37
Troubleshooting	39
Block Diagram	41
Specifications	42
Service	44
The Warranty	45
Installation Notes	47
Foxtrot Box Step	48

Network Settings	
Default IP Address	192.168.0.249

Introduction

When a whole-house audio system demands high levels of audio performance, but the physical installation space is limited, the AudioControl Director M6400 and M6800 are ideal solutions. Requiring only two rack spaces, the M6400 16 channel power amplifier produces at least 65 Watts per channel into 8 Ohms, and 100 Watts per channel into 4 Ohms, with all channels driven. The M6800 produces at least 100 Watts per channel into 8 Ohms, and 200 Watts per channel into 4 Ohms. Extensive protection features prevent damage to your loudspeakers.

Congratulations!

You are now installing a component which will dramatically improve the performance of any distributed audio system, especially those utilizing in-wall, in-ceiling, and invisible speakers. Ethernet control, unparalleled energy efficiency, rack saving compact design, superb sound quality and bulletproof reliability are just a few key features of The Director M6400 and M6800.

These 16 channel power amplifiers provide high levels of power, pristine sound quality, flexible matrix input switching, plus a number of installation-friendly features that makes them the perfect product for performance oriented audio systems. The

Director M6400 and M6800 are American-designed and built, "set and forget" components which will provide a lifetime of trouble-free service for your multi-room audio system.

The Director M6400 and M6800 are designed and manufactured by AudioControl, the only electronics company in the world that specializes in amplifiers, equalizers, signal processors and audio analyzers. Our passion for high quality, meticulous attention to detail, and pro sound heritage shows itself in the dozens of awards we have won for our designs, products, and service.

Now, as when we began, our greatest satisfaction is our reputation for sonic excellence and reliability among people just like you throughout the world.

This is a professional installer's manual. We assume you are experienced with multi-channel amplifiers and the use of Ethernet. The product setup, adjustment and operation requires network access. This manual is designed to help you get the best out of the amplifier. The M6400 and M6800 are identical in operation except for the different power output, and this manual covers both models. The illustrations shown in this manual are of the M6400.

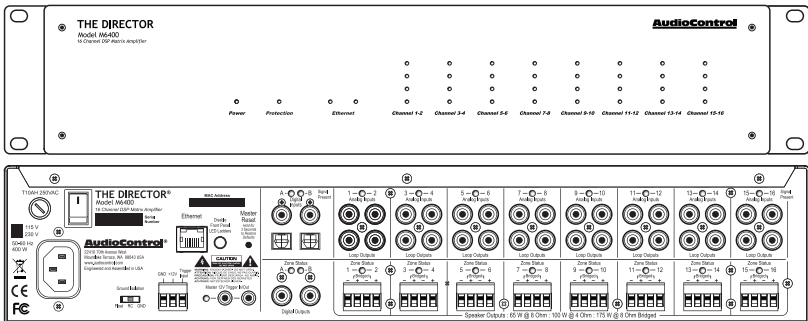

Features

Here are some of the features that make The Director M6400 and M6800 very unique, unlike any other amplifier:

- **Digital and Analog Input Matrix**
Each zone can select and play any digital or analog input. The high-resolution digital inputs accept 32-96 kHz, 16/24-bit digital signals. Each zone has a pair of RCA connectors as an analog loop output, for example: to share that zone's source with another Director unit. The digital outputs can also play any analog or digital input source.
- **High Power Levels**
The M6400 has 16 channels of 65 Watts each into 8 Ohms, or 100 Watts into 4 Ohms. Each channel pair can also be run in bridged mono at 175 Watts into 8 Ohms. The M6800 has 16 channels of 100 Watts each into 8 Ohms, or 200 Watts into 4 Ohms. Each channel pair can also be run in bridged mono at 400 Watts into 8 Ohms. Each high-efficiency amplifier is made from discrete components.
- **Superior Sound Quality**
Pristine sonics happens first in all AudioControl designs and is not compromised by any other feature.
- **Unparalleled Energy Efficiency**
From the point of view of saving electricity, the Director amplifier has no equal. It is VERY energy efficient during operation, and equally impressive during standby.
- **Ethernet Control**
Via a browser or Telnet commands, you can control and query almost all the functions, mute zones, change source inputs, recall EQ presets, check line voltage, display protection logs, and get an email if something goes wrong.
- **Signal Processing**
You have at your command: graphic equalization, parametric equalization, tweeter protection filters and low frequency cutoff filters. In addition, you can set up any zone with low-pass and high-pass channels for a two-way setup. The equalizer settings are ganged with left and right channels together, or separately. Plus, there are six EQ presets per zone to save and recall settings.
- **LightDrive Anti-clipping**
With durability in mind, AudioControl's LightDrive anti-clipping protection defends the system against clipping, distortion, damage, and even teenage parties. The Director M6400 and M6800 feature the latest evolution of LightDrive which adds a power-supply-tracking instantaneous dynamic control to the smooth sound of the traditional AudioControl LightDrive.
- **Self Resetting Protection Features**
Protection features are extensive and include thermal, short circuit, clipping, ultrasonic and DC offset among others. If the fault is removed, the Director resets. Plus, it can send you an email if something happens.
- **Pacific Northwest Heritage**
We make this product in the USA, and we are very proud of that fact. What is more important is the care we craft in at every step, and the extensive knowledge we have in all aspects of the product. Plus, we back this up with a conditional five year warranty.

THE DIRECTOR™

Model M6400, M6800

Installation Manual

Complimentary Features

- **DHCP:** An IP address is obtained via DHCP by default. If a DHCP server is not found on the network, The Director M6400 and M6800 will default to **192.168.0.249**.
- **UPnP:** Device discovery is enabled on The Director M6400 and M6800 for ease of connectivity from a PC.
- **Numbering:** In the device discovery / UPnP window, if you are using multiple Director amplifiers, you will find that each Director is numbered in the sequence they were added onto the network.
- **Groups:** Grouping has been enabled for quick control of zones through Telnet commands. Up to 4 groups can be defined for control over Standby and Source Selection.
- **Import/Export:** Exporting and Importing of the amplifier's settings – including EQ settings – has been enabled. Now you can configure your EQ settings as a template and apply these to each Director M6400 or M6800 amplifier in your system. A little refining of those settings for each amp and you will be in and out in no time.
- 16 channels of AudioControl amplification
- Any zone can play any input source
- Efficient power amplifiers and power supplies
- Power consumption is less than 2 Watts in standby
- Rack mountable 2U form factor
- Removable rack ears
- Light weight
- Stackable with other Director or Architect Models
- Signal sense independent for each zone
- Input assignment independent for each zone
- Super wonderful signal processing allows for a wide variety of EQ options and adjustments
- 12V Master trigger usable with contact closure or 12V external source
- A and B digital inputs assignable to any zone
- A and B digital outputs assignable from any analog or digital input
- Analog RCA loop-through outputs

Quick View

Front Panel

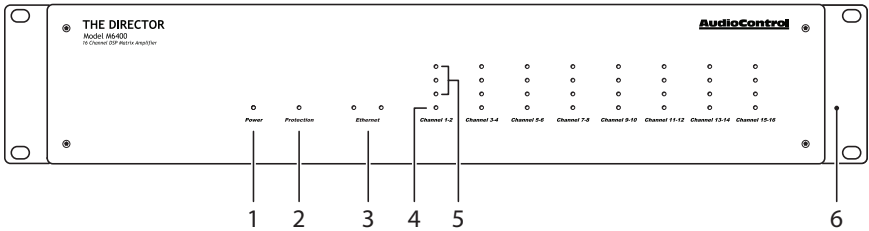

1. Power LED
2. Protection LED
3. Ethernet Status LEDs
4. Zone Status LED
5. Zone Level LED Ladder
6. Rack Mount Ears

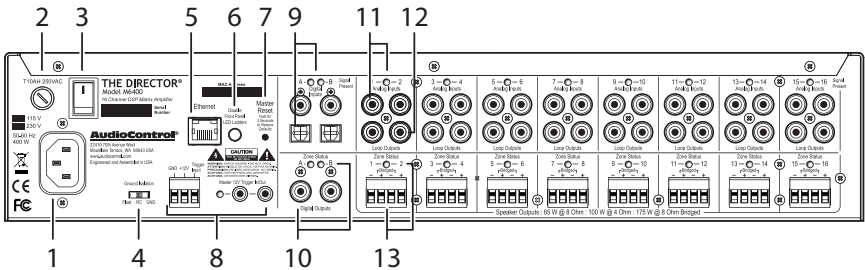

Rear Panel

1. AC Input
2. AC Fuse
3. AC Power Switch
4. Ground Isolation Switch
5. Ethernet Port
6. Disable front LED Ladders
7. Master Reset Button
8. Master Trigger
9. Digital Coaxial and Optical Inputs A/B and LEDs
10. Digital Coaxial Outputs A/B and LEDs
11. Analog RCA Line Level Inputs and LEDs
12. Loop Outputs
13. Speaker Outputs and Zone Status LEDs

THE DIRECTOR™

Model M6400, M6800

Installation Manual

Getting Started

1.  Turn off power to all components before making any connections.
2. When making connections, designate red RCA plugs as right, and designate white, black, or grey plugs as left. This is a good idea for all signal connections made in your audio system. The key is consistency. Stick with the same color coding and you'll reduce possible problems.
3. Whenever possible, keep power cords away from signal cables to prevent induced hum. This is especially important if you bundle the cables to keep the installation neat looking.
4. Use quality interconnect cables. We know from experience that really cheap cables can cause a multitude of problems. They tend to break inside or corrode, causing a loss of signal or hum. They also have poor shielding.
5. If you need to run the RCA audio cables more than 20 feet, consider using an active balanced line driver for the signals. This will provide better noise rejection against nasty things like hum, spikes, local talk radio, and metaphysical paranormal phenomena, etc. The AudioControl balanced line driver components (BLD-10, BLR-10 and BLX-10) are an excellent way to send audio over long distances with standard Cat-5 wiring. Check them out at audiocontrol.com.
6. If you are using the A and B digital inputs, and running higher resolution sample rates (96 kHz), use high-quality interconnect cables.
7. Dance in a fairy circle at midnight, on the first full moon of the new year. Ask Queen Mab for the IP address.
8. Connect The Director M6400 or M6800 to the network with an Ethernet cord, preferably one in good condition without a broken tab or covered in Marmite®.
9. Open your favorite internet browser and open the web server within the unit. It will show all features and controls of the unit.

Installation Examples

The next pages show some typical installations of The Director M6400 or M6800, and also shows some of our fine Audio-Control components.

Installation with 2 Bijou 600 Amplifiers

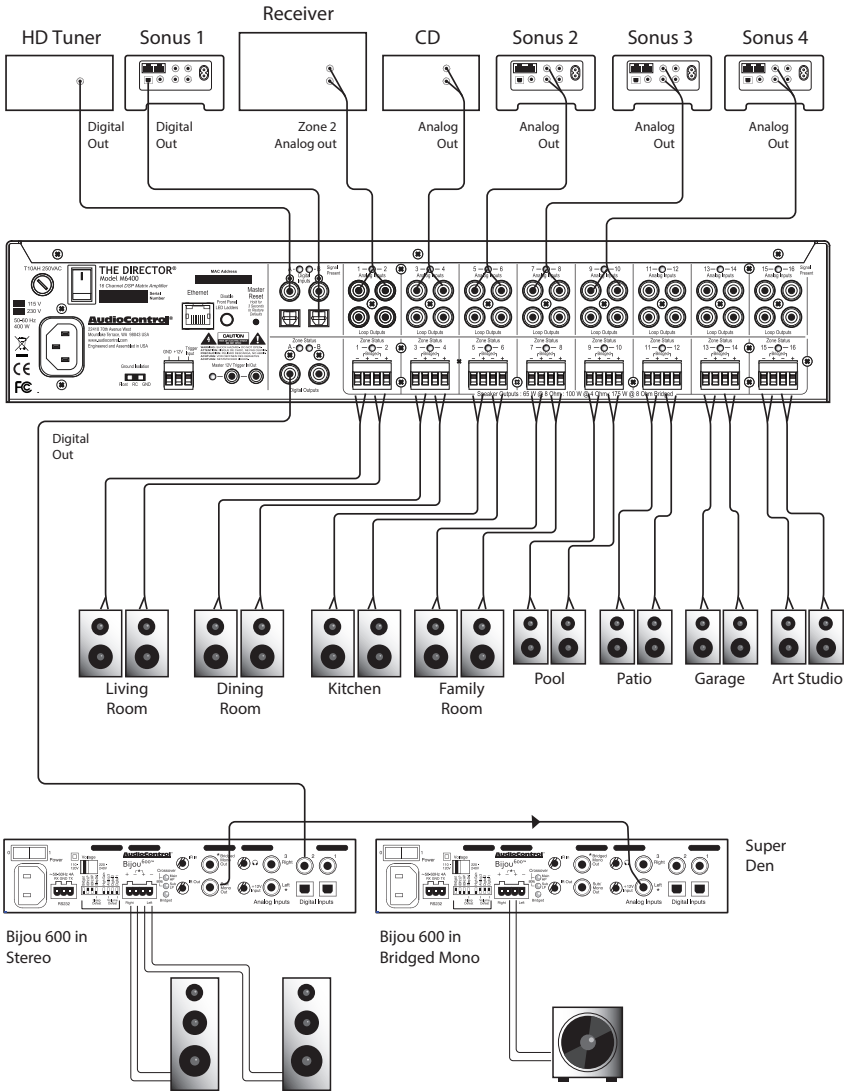

THE DIRECTOR™

Model M6400, M6800

Installation Manual

Installation with an Architect 2660

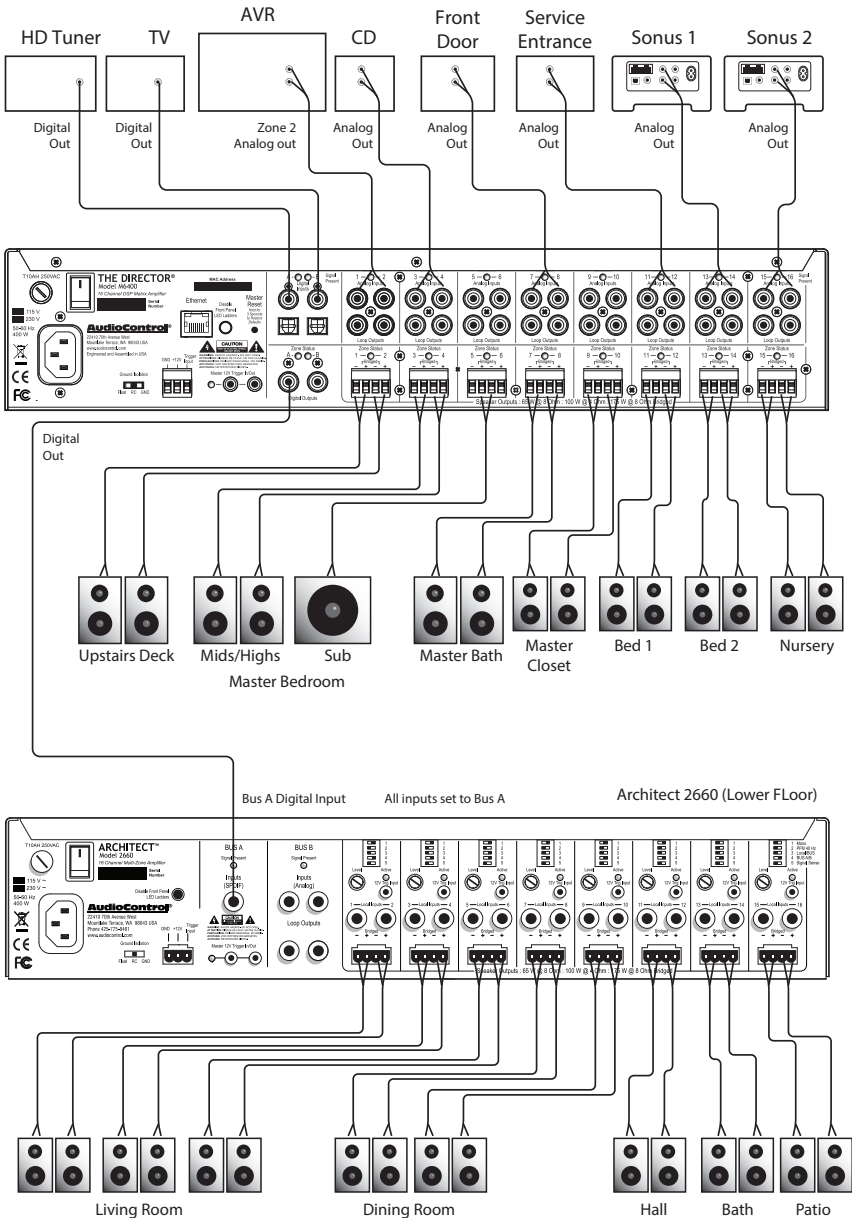

Installation with one Bijou 600 Amplifier

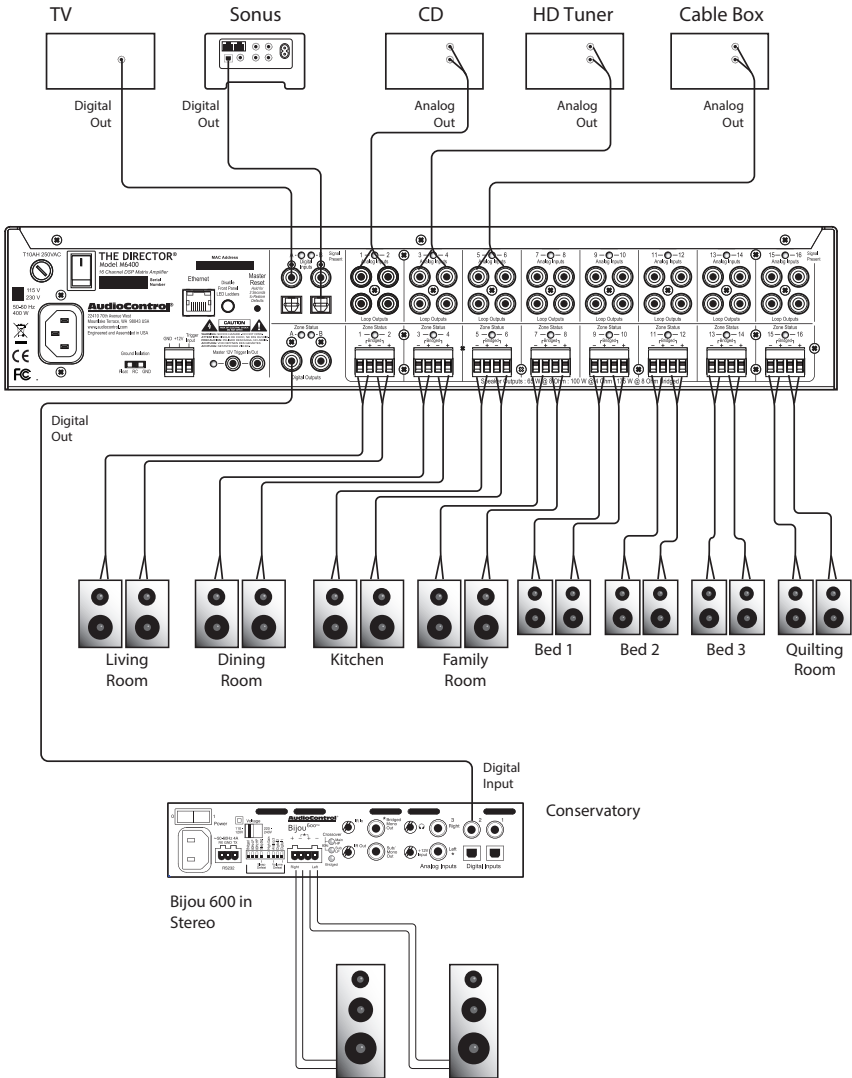

THE DIRECTOR™

Model M6400, M6800

Installation Manual



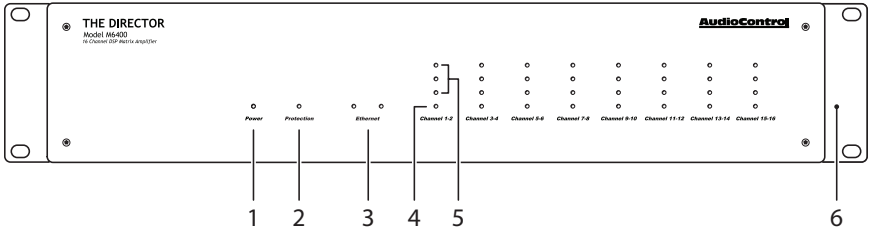



Front Panel Features



1. **Power LED** – This dual color LED indicates when the unit is in standby, on, or off
 - Red: The unit is in standby mode and is ready to be turned on via Ethernet or 12V triggering
 - Blue: The unit is on
 - Green: Coffee brewed
 - OFF: The unit is powered off
2. **Protection LED** – This red LED will illuminate briefly during turn on/off phases, and if a fault is detected in any amplifier or the power supply (such as overheating, over-current, or DC offset). If a fault is detected, then the unit will go into its protection mode to prevent any damage to loudspeakers, and to allow cooling.
3. **Ethernet LEDs** – These indicate the status, readiness, and willingness, of The Director’s Ethernet communications protocol to (getting all technical for a moment) strut its funky stuff. The green LED glows when the Ethernet is connected and operational, and the yellow LED blinks during data activity.
4. **Zone Status LED** – This dual-color LED indicates when the zone is in fault mode, active, or in standby.
 - Red: The zone has detected a fault, such as a DC offset or a load short circuit.
 - Blue: The zone is active
 - OFF: The zone is in standby
5. **Zone Level LEDs** – These three LEDs light from the bottom to the top depending on the zone’s output level (-33, -20, -10 dBFS). These LEDs can be turned off using the rear panel switch.
6. **Rack Mount Ears** – The unit comes supplied with removable rack mount ears. These allow the unit to be rack mounted in a standard 19” wide rack, with a 2U height. Use standard rack mount screws and washers to secure the unit in a rack. The unit does not have to be supported at the rear if the rack is located in a fixed location.

To remove the rack ears (making the unit 17” wide), first unplug the power cord, and then locate and undo the four screws securing each ear to the side of the chassis, and remove the ears. Replace the screws securely back into the chassis. Do not remove any of the other screws from the chassis or top cover. There are hazardous voltages inside the unit. Keep the rack ears in a safe place.

LED Function Table

LED	Color	Description
 Power	Red	The unit is in standby mode
	Blue	The unit is on
	Off	The unit is powered off, or all the lights are off in your town
 Protection	Red	The unit has detected a fault and is in protect mode*
	Off	The unit is operating normally, or it is powered off
ZONE LEDs	Color	Description
	Blue	-10 dBFS zone output level
	Blue	-20 dBFS zone output level
	Blue	-33 dBFS zone output level
 Channel 1-2	Red	The zone has detected a fault, or a smooth-jazz saxophone solo, and is in protect mode
	Blue	The zone is active
	Off	The zone is in standby

*The protection LED also comes on for a short time during power up or down

Rear Panel Features

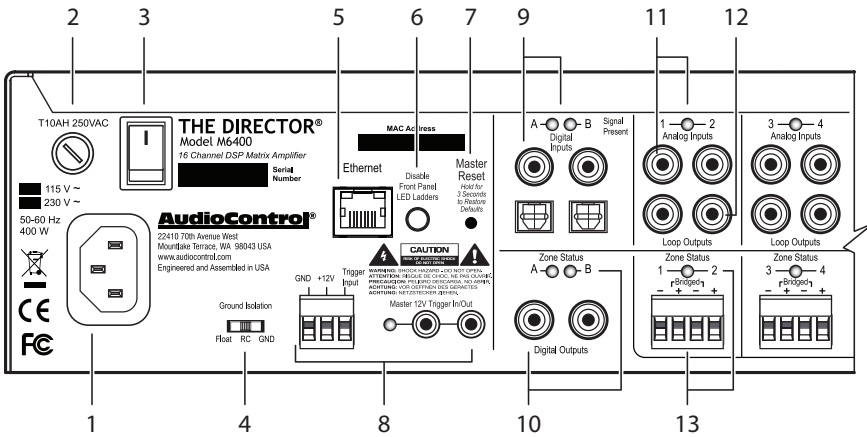

AC section



When rack-mounting the unit, make sure that the power cord and the AC power switch remain readily accessible.

- 1. AC Input** – Connect the supplied AC power cord securely to this input. Plug the other end into an AC mains outlet of the correct voltage rating for your unit. They are either 100 -120 VAC (50 – 60 Hz) or 220 – 240 VAC (50 – 60 Hz); look at the check box to see how your unit has been configured. The voltage setting is not user-settable. This unit is a class 1 device, do not defeat the safety ground connection or use a power cord that does not have the safety ground pin.
- 2. AC Fuse** – The main power supply fuse may be checked or replaced. Make sure that the power cord is unplugged from the AC mains first. Then use a flat-headed screwdriver to undo the fuse carrier from the fuse holder. Inspect the fuse and replace with the exact same type indicated on the unit.

The use of any other type of fuse may lead to an unsafe condition. If the fuse blows again immediately, then unplug the power cord and contact our fine folks in customer service. Do not open the unit, as there are no user-serviceable parts inside, and dangerous voltages exist.

- 3. AC Power Switch** – This switch shuts off the main AC power. Normally the only time you need to turn this off is if the system is going to be shut down for an extended period of time. Use the Ethernet or master trigger inputs to switch the unit between standby and on.

Also turn the power switch off during lightning storms, wind storms with frequent power outages, or when a giant robot from space is heading to the power station for a light lunch.

- 4. Ground Isolation Switch** – This switch selects the level of isolation between the audio signal ground and the AC earth ground. In normal operation this switch should be in the GND Ground position. If there is trouble with an AC

ground hum, try the other two settings for the best operation. For safety, the chassis is always connected to the earth ground regardless of the switch setting.

5. **Ethernet LAN Port** – This standard port allows The Director to be connected to a 10BaseT network via CAT5 cabling. The unit can then be controlled using its internal web server, accessible through standard and popular (and some unpopular) web browsers. No external software is required to run The Director. See the section on Internet Connectivity and Control for detailed information.
6. **Disable Front Panel LED Ladders** – The front panel LED ladders show the output levels of each zone. If this is distracting, or your pets or children keep getting hypnotized, press this switch in to turn off the LED ladders. This switch does not affect the Power, Protection, or Zone Status LEDs.
7. **Master Reset** – If things are not going well, for example you are unable to communicate with The Director, press and hold down this button for more than 3 seconds. This will reset the internal Ethernet settings and other odd things, and hopefully lead you along the pathway to Ethernet communications once again. Warning: Do not do this while turning on the power switch, because all flash memory will be erased, and the milk in your fridge will go bad. In this case you will have to go to the store and get more milk, and inquire from our fine lads in technical support about the latest firmware file.
8. **Master Trigger** – If you are not using the Ethernet connection to turn the unit on, then you can use the TS 1/8" connectors or the 3-pin block connector to turn on the unit or place it into standby mode. Any one of these three connections can be used as a trigger

input. For example, you could have an external device such as one of our glorious AudioControl home theater receivers, turn on The Director when it is turned on.

If you are not using the Ethernet connection to turn on The Director, and there is no trigger voltage present at any of these trigger inputs, then the unit will be in standby, with all zones muted.

LED indicator – This LED is blue when the master trigger input is active, and off when it is inactive.

Digital Inputs/Outputs

9. **Digital Inputs** – There are coaxial and optical digital inputs for A and B.

The digital signals are transferred directly to the advanced DSP section, and are then available to any zone or all zones at the same time. The digital inputs are selected for any or all zones using The Director's web page interface.

The Signal Present LEDs light whenever a digital input signal is present at the A or B inputs.

10. **Digital Outputs** – These S/PDIF digital outputs use standard RCA coaxial connectors.

The digital signals from each of these outputs can be a copy of any zone's input pair (converted internally from analog to digital), or a copy of the digital inputs A or B. This is selectable using The Director's web page interface. For an example, this output can be sent to the digital inputs of another Director M6400 or M6800 unit.

The Zone Status LEDs alight with joy whenever the digital output is active.

THE DIRECTOR™

Model M6400, M6800

Installation Manual

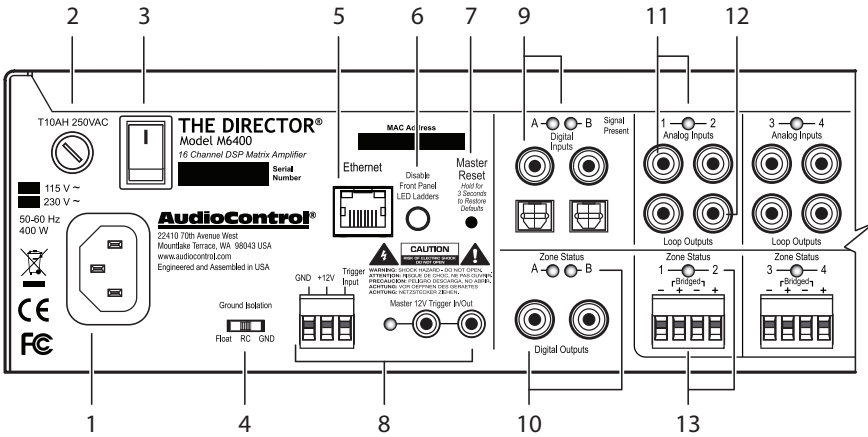

Zone Section

(All details are the same for each zone)

11. **Analog Inputs** – These are line-level analog RCA inputs. Analog signals entering here from sources such as CD players, DVD players, and TV outputs, may be selected to play in this zone, any other zone, all zones at once, and the digital outputs. This extraordinary flexibility is made possible by taking ballet lessons from an early age, and The Director’s web server interface menus. The LED will light when an analog input signal is present.
12. **Loop Outputs** – These line-level analog RCA outputs are a hard-wired copy of whatever is coming in on the analog inputs directly above. These can be used to feed the incoming signals to the analog inputs of another Director M6400, M6800, or other external equipment such as stereo zone amplifiers.

Speaker Connections

13. Speaker Outputs – This 4-pin connector allows easy connection of two speakers for stereo operation, or one speaker for bridged mono operation.

Stereo Speaker Connection:

Note the polarity markings for each pair of outputs.

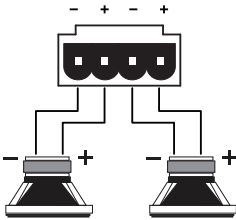

The speaker impedance should be 4 Ohms minimum in stereo operation.

Bridged Mono Speaker Connection:

Note the polarity markings of the inner pair of connections. In this mode, the input signals are combined in mono, and the power from both channels is combined to drive a single, more powerful, speaker.

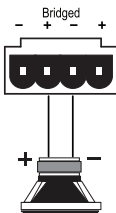

The speaker impedance should be 8 Ohms minimum in bridged mono operation.

To set the output to be in mono, use The Director's web server Operation menu (the first page that shows up) and click on the Mono box for this zone.

Speaker Wiring

Establish a standard connection color code and stick with it. One conductor of the speaker wire is normally marked by a different color (silver versus copper) or there is a ribbing on one side. Typically this marked conductor is used for the positive (+) speaker leads. Some wires have positive and negative printed right onto the wire jacket.

Match the polarity markings on the unit with the polarity markings on your speakers. If the wiring is incorrect then the speakers will be out-of-phase, with a noticeable decrease in the bass response and less than goodly-sounding awesomeness.

See the next page for some handy information about speaker and wiring impedance.

THE DIRECTOR™

Model M6400, M6800

Installation Manual

Speaker and Wiring Impedance

Speakers, like other resistors, when wired in parallel “show” lower values than the individual components. Here are two examples for calculating speakers wired in parallel:

Calculating Impedance

For three 8 Ohm speakers wired in parallel (pluses connected to pluses) the impedance is $1/8 + 1/8 + 1/8 = 3/8$
Then take the inverse or $8/3 = 2.66 \Omega$

For two 8 Ohm speakers wired in parallel (pluses connected to pluses) the impedance is $1/8 + 1/8 = 2/8$
Then take the inverse or $8/2 = 4 \Omega$

Often the real world is more complicated than theory, and for speakers this is the case. An eight Ohm speaker is not eight Ohms at all frequencies. Plus passive crossover networks add their own changing conditions. Be aware of speakers that have significant dips from “nominal” val-

ues in portions of their frequency range, and speakers that are rated at unusual impedances, for example 3.5 Ohms. The Director M6400 and M6800 are tolerant of lower impedance loads, however, all good designs use some margin of error.

Your choice of speaker wire gauge and the length of the runs, also affects the speaker impedance load presented to the amplifiers. As you can see in this table, even fairly short speaker runs can have significant resistance if you use a smaller wire gauge. This can be a benefit if you are paralleling lots of speakers. The wire itself acts as an impedance limiter, since the amplifier cannot see a speaker load lower than the resistance of the wire. The downside of this wire resistance is that you waste some part of the total power available to the speakers.

Speaker Wire Resistance:

Wire Gauge versus Run Length

Wire Gauge	Run Length				
	25'	50'	100'	250'	500'
24 GA	1.3Ω	2.6Ω	5.1Ω	12.8Ω	25.7Ω
22 GA	0.8Ω	1.6Ω	3.24Ω	8.1Ω	16.0Ω
20 GA	0.5Ω	1.0Ω	2.0Ω	5.0Ω	10.1Ω
18 GA	0.3Ω	0.6Ω	1.28Ω	3.2Ω	6.4Ω
16 GA	0.2Ω	0.4Ω	0.8Ω	2.0Ω	4.0Ω
14 GA	0.1Ω	0.25Ω	0.5Ω	1.26Ω	2.5Ω
12 GA	0.08Ω	0.16Ω	0.32Ω	0.8Ω	1.6Ω

12 Volt Trigger Ins and Outs

The Director M6400 and M6800 have five ways you can bring the unit from standby to turn on and be ready to serve. In addition, you can use the triggers from The Director to turn on more Directors or other components as well. All this flexibility can be a little daunting, so the table below should make it a tad clearer:

Method	How Triggered	LED Indicator	Mini Jacks Powered*
1	Ethernet	Ethernet Triggered	No
2	12 volt mini plug input*	12 v Trigger Active	Yes, unused jack
3	Jumped Phoenix connector	12 v Trigger Active	Yes
4	Contact closure on Phoenix connector	12 v Trigger Active	Yes
5	12 volt input on Phoenix connector	12 v Trigger Active	Yes

* +12 volts on tip, mono jack

The following details apply if you do not want to use the Ethernet web server to turn on The Director M6400 or M6800.

3-pin connector – To remotely turn on the unit, use either a contact closure between the Trigger Input and the +12V output, or an external +12V trigger between the Trigger In and GND terminals. The +12V output is not designed to power other pieces of equipment or jump start your car.

Pinout:

GND Ground
+12V Output
+12V Trigger Input

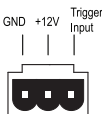

1/8" TS mono jacks – These are wired in parallel to each other, and work in conjunction with the 3-pin connector. Either input can receive a +12V trigger which will turn on the unit. This will then allow the unused jack to output +12V that can be used to turn-on a second unit. If the 3-pin connector is used to trigger the unit, then both of the 1/8" jacks can be used to provide output triggers to other units.

Pinout:

Tip = +12V Trigger Input
Sleeve = Ground

THE DIRECTOR™

Model M6400, M6800

Installation Manual

Power Up Process: When a +3 to +12V signal is sensed at the trigger input of either of the 1/8" TS connectors, or the 3-pin connector, the rear panel master trigger indicator LED will change from off to blue. All the zones will be held in standby for about 2 seconds until the power supplies have fully charged and performed their self-tests. During this short process, the front panel Power and Protection LEDs will be red. Once this is complete, the Power LED will turn blue and the Protection LED will turn off.

Power Down Process: As soon as a 0V signal is sensed at the master trigger inputs, all zones will be muted and placed in standby, and the rear panel master trigger LED will change from blue to off. The front panel Power LED will remain on, as the main power supplies will be still energized.

If the master trigger Inputs remain at 0V for 2 seconds, the main power supplies will shut off; the front panel Power LED will change from blue to red. The Protection LED will flash red once during the power-down process.

The trigger input is biased towards ground. This keeps the unit in standby when nothing is connected.

If you are not using master triggering or the Ethernet connection, then you **must** install a short wire link from the +12V output to the trigger input. To put the unit into standby, remove the link.

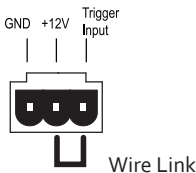

To trigger ON with a contact closure:

Connect the contact closure between +12V and Trigger Input

To trigger OFF with a contact closure:

Connect a 1 k Ω resistor between +12V and Trigger Input

Connect the contact closure between Trigger Input and GND

To use an external 12V trigger:

Connect the external ground to the Director M6400 or M6800 GND

Connect the external +12V output voltage to the Director M6400 or M6800 Trigger Input

Ventilation

This may be as good a time as any to have "the talk" about ventilation. The Director M6400 and M6800 feature cool-running efficient switch mode power supplies and Class D amplifiers, and they are equipped with thermally controlled fans. They are still 16 channel amplifiers, and therefore require plenty of good ventilation to properly cool.



Please be advised that no more than 4 Director models may be stacked together. Any more than that, then a rack space above and below is required for adequate ventilation.



Review the heat load specifications and ensure that your rack room meets these requirements.

If the amplifier should overheat, a thermal sensor will put it into standby mode, allowing the heatsink to cool down. Once the amplifier has cooled to a safe operating temperature, the amplifier will reactivate. If this occurs often, identify the cause of the problem and take corrective action, for example:

- Provide additional ventilation

- Do not install in a sealed location with limited or no airflow

- Install a fan in the rack

- Make sure that the amplifiers are not overloaded with speaker impedances below the recommended minimum

- Check that there are no short circuits in the speaker cables or speakers. Note: Each zone will shut off independently when a short circuit is detected.

Ideal Spacing 1U rack space or more above and below each pair

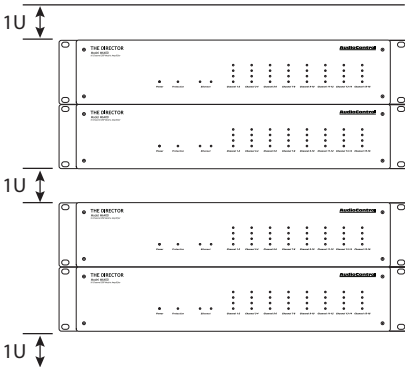

No more than four units can be stacked without a rack space between them. Allow 1U rack space or more above and below each stack of four.

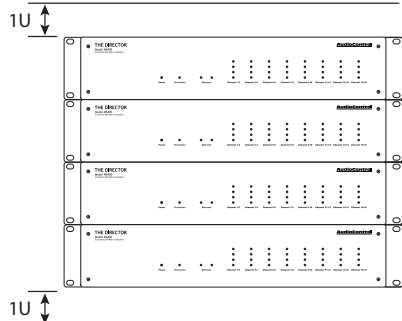

THE DIRECTOR™

Model M6400, M6800

Installation Manual

Internet Connectivity and Control

Setting up The Director M6400 or M6800 is a breeze. Just plug it in to an existing network and let the DHCP server assign The Director M6400 or M6800 amplifier an IP address. You should take note of the unit's MAC address there on the back at this time – maybe write down the last couple of values. After the amp has taken an IP address from the DHCP server (give it a few seconds), you can scan for The Director's MAC address across the network using your favourite network scanner – like Fing or Angry IP Scanner. After you have the unit's IP address, type it into your browser and The Director's Operations page will open up.

Other than connecting to the browser for initial set up, configuration and EQ settings, you will be able to control the amplifier via Telnet. This is done through the telnet port 23.

Control Using a Browser

For Microsoft operating systems:

There are multiple ways to connect to The Director amplifier. The simplest way is to connect The Director via the Ethernet port to a network with a DHCP server. The Director will obtain a local address from the DHCP server.

If no DHCP server has been enabled in your network, or you would like to directly connect to The Director, use an Ethernet cable and connect the two devices together. The default IP address of The Director is 192.168.0.249 when a DHCP server is unavailable, so in order to connect to The Director, you will need to give your computer a static IP address.

In your Windows based computer, change your computer's IP address to a static address of 192.168.0.x – where x is a value between 1 through 254, but not using 249. If you don't know where to start to find out how to give your computer a static IP address, please consult the Interwebs.

Be sure not to use a static IP address for your computer that is in use by another device – an IP address should be unique across the local network – if it is not you're going to have a bad time.

Important Note:

DCHP is default for The Director M6400 and M6800. However, if a DCHP server is not found, the Director's default IP address is 192.168.0.249. If you aren't using DCHP and plan to assign static addresses, individually set the IP address by connecting directly to The Director with a computer first. Never allow two devices with the same IP address on the network.

For Apple/Mac Desktops and Laptops:

Your easiest method for connecting with a Mac is to directly connect to The Director. The default IP address of The Director is 192.168.0.249 so in order to connect to The Director M6400 or M6800, you will need to give your computer a static IP address.

Change your Mac's IP address to a static address of 192.168.0.x – where x is a value between 1 through 254, but not using 249. If you don't know where to start to find out how to give your computer a static IP address, please consult the Interwebs.

Be sure not to use a static IP address for your computer that is in use by another device – an IP address should be unique across the local network – if it is not you're going to have another bad time.

Communications Options

The Director's web server "Device Configuration" page has lots of communications options you can play about with to your own delight or at your peril. If you know what you are doing, then you will feel right at home.

Here are a few notes:

Server Gateway must be specified in order to access the SNTP time server, likewise for your email alerts to function properly.

DNS must be specified as well for the SNTP and SMTP functions to work – 8.8.8.8 (Default) or 8.8.4.4 are public DNS servers that the good folks at Google have enabled for you to use.

Control Via Telnet Commands

To control The Director M6400 or M6800 in an automation network, you will need nerves of steel, and a controller that can send and receive telnet commands and responses.

The command and response structures of the controls provided via telnet are in simple human language. **Power on** is simply "power1" followed by a carriage return to end the command. Command feedback is confirmed by an echo of the command, followed by a carriage return, then another statement of "01" followed by the command string, then a carriage return and a line feed to end the response string. If there is a value-change like volume up, then the confirmation response will include the new value at the end of the string.

Telnet Session Length:

Sending a command to the The Director opens a telnet session – nothing tricky, just send it a command and it will respond. The session will remain open for 4 hours, and then close. If another command is received within that 4 hours, then the clock restarts. The session will close 4 hours from the time of the last command received. If your automation system treats such activity as dropping off the network, then pinging it in the early AM every day is probably a good practice.

Control Command Examples:

Increment volume by 1, in Zone 3, where volume before the command is 51:

Command: Z3vol+<CR>

Response: Z3vol+<CR>

01Z3vol52<CR><LF>

To turn on main power:

Command: power1<CR>

Response: power1<CR>

01power1<CR><LF>

To mute or turn Zone 5 off:

Command: Z5off<CR>

Response: Z5off<CR>

01Z5off<CR><LF>

Note:

The query ZONEON? returns a description of the on state of all the zones, where each zone is separated by a space. 1 equals on, and 0 equals off. So if zones 6 and 7 are on and all the other zones are off the information will be displayed like: 0 0 0 0 1 1 0 0 0. Also note that the last two values in position 9 and 10 are reflecting the state of the digital outputs. The response to the query ZONEOFF? will return the opposite values if zones 6 and 7 are off as it is confirming that the zones are off so that value is positive: 1 1 1 1 1 0 0 1 1 1.

Please visit our delightful website for further information and a splendid table of control commands:

[www.audiocontrol.com/
home-audio/network-amplifiers/
the-director-model-m6400](http://www.audiocontrol.com/home-audio/network-amplifiers/the-director-model-m6400)

(As things in the fast-paced world of technical documentation are constantly changing, visiting our website is one way to make sure you have the latest information.)

Operation Tab

This is the first page you see when connecting to The Director M6400 or M6800 via a web browser.

Lock: Click the padlock logo to lock or unlock the pages for editing. Locking will provide protection from accidental or not so accidental adjustments of the unit configurations.

Build: This shows the version number of the currently installed firmware.

Global Settings: This section shows the AC line voltage status, the overall temperature of the unit, and allows you to turn the power on or off, and the signal sensing on or off. The log count is also a link to a pop up page which will describe the most recent events.

AudioControl
www.audiocontrol.com
Operation
Device Configuration
Zone Configuration
Homeowner

The Director Matrix 6400: Director Matrix 6400

Build: v8.13.1800

Global Settings:

AC Line Voltage StandBy

Power **Off**

Signal Sense **Off**

Temperature 176°F / Warm

Logs [None](#)

Output	Name	Zone	Group	Mono	Standby	Status	Input Source	Trim	Temperature	Protection
1	Zone 1	1	N/A	<input type="checkbox"/>		Mute	Channel 1-2	+0.0	174°F / Warm	Normal
2	Zone 2	2	N/A	<input type="checkbox"/>		Mute	Channel 3-4	+0.0	174°F / Warm	Normal
3	Zone 3	3	N/A	<input type="checkbox"/>		Mute	Channel 5-6	+0.0	179°F / OverTemp	Normal
4	Zone 4	4	N/A	<input type="checkbox"/>		Mute	Channel 7-8	+0.0	179°F / OverTemp	Normal
5	Zone 5	5	N/A	<input type="checkbox"/>		Mute	Channel 9-10	+0.0	176°F / OverTemp	Normal
6	Zone 6	6	N/A	<input type="checkbox"/>		Mute	Channel 1-2	+0.0	176°F / OverTemp	Normal
7	Zone 7	7	N/A	<input type="checkbox"/>		Mute	Channel 13-14	+0.0	177°F / OverTemp	Normal
8	Zone 8	8	N/A	<input type="checkbox"/>		Mute	Channel 1-2	+0.0	177°F / OverTemp	Normal
Digital Out A	Digital Out A			<input type="checkbox"/>		Mute	Digital In A	+0.0		Normal
Digital Out B	Digital Out B			<input type="checkbox"/>		Mute	Digital In B	+0.0		Normal

Groups: Grouping allows for channels to be grouped (there are 4 groups to choose from in the tiny box) for control via telnet for simple and efficient operations. The telnet commands are listed on our website of destiny. Grouping allows for quick control over the on/off and signal source states of each group.

Mono: Click this button to combine both channels in this zone into mono. This is useful if you want to connect a single speaker, such as a subwoofer, in bridged mono, thus combining the power of the two amplifiers into one. Make sure your speaker's impedance is 8 Ohms or higher. Alternatively, you could leave the two speakers connected as normal and they will both play the same. This can be ideal where stereo sound is not really needed.

Standby: The standby on/off buttons control the state of each individual channel – whether the channel is on or not.

Input Source: Allows you to choose where each channel pair is getting its input source. The small drop-down menu shows the available input sources.

Trim: Trim the levels of the zone output. The range of adjustment is suitable for balancing SPL in grouped zones, for example, 3 sets of speakers grouped for a living room. It will also serve as a way to limit volume in a particular zone if, for some reason, you don't want to use the maximum volume setting found in the zone configuration page. Input levels can be set using the Device Configuration Tab.

Temperature: Provides the status of the channel temperature.

Protection: Shows the channel protection status.

Device Configuration Tab

In this menu, you can rename the amplifier, rename each channel pair or zone, rename the input sources, set the global networking parameters, save your settings, export your signal processing EQ settings and configuration data as a file, and Import previously-exported settings, even from another Director M6400 or M6800 amplifier in the system, or pre-designed EQ curve templates.

Be sure to select "Save Settings" after you have completed your changes on this page, otherwise your changes will disappear and you will be snookered.

The renamed zones and input source names will appear in the other menu tabs and drop-down menus.



www.audiocontrol.com



Amp Name



Zone Output Names

Zone 1 : 1
 Zone 2 : 2
 Zone 3 : 3
 Zone 4 : 4
 Zone 5 : 5
 Zone 6 : 6
 Zone 7 : 7
 Zone 8 : 8
 Digital Out A : Digital Out A
 Digital Out B : Digital Out B

Channel Input Names

0.5 V rms Channel 1-2 : 1-2
 0.5 V rms Channel 3-4 : 3-4
 0.5 V rms Channel 5-6 : 5-6
 0.5 V rms Channel 7-8 : 7-8
 0.5 V rms Channel 9-10 : 9-10
 0.5 V rms Channel 11-12 : 11-12
 0.5 V rms Channel 13-14 : 13-14
 0.5 V rms Channel 15-16 : 15-16
 Digital In A : Digital In A
 Digital In B : Digital In B

Device Address DHCP?
 Device Netmask
 Device Gateway
 DNS Server

SMTP Server Address
 SMTP Port
 Return Address
 Logging Email Address
 Enable Email Alerts Custom
 SMTP Server Address
 SMTP Port
 Time Offset (minutes)
 Enable Daylight Savings
 Current Time

Import Settings No file selected.

Export Settings

Firmware No file selected.

THE DIRECTOR™

Model M6400, M6800

Installation Manual

Here is one example where the amp, zone, and input names have been changed:

The screenshot shows the 'Device Configuration' tab for an AudioControl amplifier named 'BATES HOTEL'. The interface includes several sections:

- Zone Output Names:** A list of 8 zones with their respective outputs: KITCHEN (1), LIVING ROOM (2), DINING ROOM (3), BILLIARD'S ROOM (4), LIBRARY (5), CONSERVATORY (6), SEWING ROOM (7), MAN CAVE (8), POOL SYSTEM (Digital Out A), and SHOWER (Digital Out B).
- Channel Input Names:** A list of 16 channels with their respective inputs: CD PLAYER (1-2), DVD PLAYER (3-4), BLURAY PLAYER (5-6), TAPE PLAYER (7-8), MP3 DOCK 1 (9-10), MP3 DOCK 2 (11-12), COMPUTER 1 (13-14), BLUETOOTH ADAPTOR (15-16), TV OUTPUT (Digital In A), and TURNTABLE DIGIT OUT (Digital In B).
- Network Settings:** Fields for Device Address (192.168.0.249), Device Netmask (255.255.255.0), Device Gateway (192.168.0.1), and DNS Server (8.8.8.8). A 'DHCP?' checkbox is checked.
- SMTP Settings:** Fields for SMTP Server Address, SMTP Port (0), Return Address, Logging Email Address, Enable Email Alerts (with a 'Custom' button), SMTP Server Address (pool.nrp.org), SMTP Port (123), Time Offset (minutes) (0), Enable Daylight Savings (checked), and Current Time (1/5/2000 00:49:02).
- Buttons:** 'Save Settings' and 'Send Update Email' buttons are located below the network and SMTP settings.
- Import/Export Settings:** 'Import Settings' (Browse... No file selected), 'Export Settings' (Save), and 'Firmware' (Browse... No file selected) buttons are at the bottom.

Here is what happens when you are save your settings using the "Save Settings" button

This screenshot shows the same AudioControl configuration page, but for an amplifier named 'Director Matrix 6400'. A 'Saving' dialog box is overlaid on the SMTP settings section, indicating that the settings are being saved. The dialog box contains the following information:

- Enable Email Alerts:** Custom
- SMTP Server Address:** pool.nrp.org
- SMTP Port:** 123
- Time Offset (minutes):** 0
- Enable Daylight Savings:**
- Current Time:** 1/5/2000 00:28:56

The 'Save Settings' button is highlighted with a blue arrow pointing to it from the left. The rest of the page content, including the zone and channel names, remains the same as in the previous screenshot.

Signal Processing Tab

Equalization of each zone's sonic goodness affects both channels within each zone. First select the zone of interest using the row of 8 buttons along the top of the signal processing display. Please see a later section for a discussion of the methods and benefits of equalization, and see the notes below regarding saving your settings. Equalization can be very powerful, however it takes some work to adjust properly, and like makeup, it can easily be done wrong. It is much easier and more accurate, if you have some instrumentation/audio analysis gear. Please see our website for details of our fine audio analyzer products that will take the guesswork out of successfully setting the EQ in each zone.

Vital Signs: This line displays a quick view of the device name, input source, group, zone status, temperature, and protection status.

Graphic EQ: Adjustment of the graphic EQ of the selected zone is done by dragging the EQ sliders to the desired position, or by clicking where you want the position/ value to be, or by clicking the +/- buttons. Note that the sliders can be moved down as well as up, and this is not a sign of weakness.

Parametric EQ: In addition (or subtraction) to the graphic EQ sliders, there are two separate parametric equalizers per zone, for the ultimate in room-acoustics problem solving (or problem creating). Each parametric EQ has adjustments for the frequency, width, and the level boost or cut. For an example of their use, if a certain frequency sets all the dentures rattling in an old folk's home, a narrow-width filter can be tried at the denture-rattling-onset-frequency, with a cut in the level.

AudioControl
www.audiocontrol.com

The screenshot displays the AudioControl signal processing interface with the following sections:

- Navigation Tabs:** Operation, Device Configuration, Zone Configuration, Homeowner.
- Zone Selector:** Eight buttons labeled Zone 1 through Zone 8, with Zone 1 selected.
- Vital Signs:**
 - Device Name: Director Matrix 6400
 - Input Source: Channel 1-2
 - Group Assignment: N/A
 - Zone Status: Mute
 - Temperature: 2 °F
 - Protection: Normal
- Equalizers:**
 - Parametric:** Controls for Band1 and Band2, including Frequency (Hz) and Bandwidth (Octave).
 - Graphic:** Sliders for 45 Hz, 150 Hz, 300 Hz, 700 Hz, 2.5 kHz, and 12 kHz.
 - Shelving:** Sliders for Bass and Treble.
 - Volume:** Max Vol (%) and Set On Volume (%) controls.
 - High and Low Pass Filters:** Type selection (Subsonic Filter & Tweeter Protection, Low Pass Mode, High Pass Mode, Band Pass Mode) and frequency settings (High Pass: 100 Hz, Low Pass: 3.5k Hz).
- Graphic Presets:** Acoustic, Bright, Party, User 1, User 2, User 3. Includes buttons for Save To Memory, Set to Flat, and Restore Factory Curves.
- Loudness and Signal Sense:** Two sets of buttons for each feature.

THE DIRECTOR™

Model M6400, M6800

Installation Manual

Shelving EQ: Just when you would be forgiven for thinking “wow, that’s a lot of EQ flexibility,” wait.. there’s more. At no extra charge, two sliders offer bass and treble EQ adjustment of the shelving kind. Shelving EQ, used in combination with the graphic EQ and parametric EQ, gives you the fine opportunity to upset things royally, or to be the better person, with kindness and EQ moderation for all. Start with the graphic EQ flat, apply a bit of shelving bass or treble EQ, and see how that sounds. Maybe that will do.

Volume: The volume slider, as the name suggests, was designed to hypnotize little kittens that might be watching the little rectangle go up and down on your screen. The effect is quite adorable. The slider can also be used to set the volume in the zone. One extra adjustment allows you to set the maximum-allowable volume per zone, such as teenager’s rooms, and one adjustment sets the turn-on volume level. The maximum level is defined as: “That threshold volume level, which if exceeded, brings forth the coming of the broom-handle thumping on the ceiling, and the loud exclamations of “turn it down.””

High and Low Pass Filters: These 4 different filter types allow you to quickly choose a design for your system, either to set up protection from low and high frequencies, set up a 2-way crossover with a subwoofer and mids/highs, or set up a bandpass filter. The filters can also be chosen slowly, with considerable forethought and care, possibly while mulling things over in your favorite comfy chair, with a cup of tea and a plate of delicious buttered crumpets. As each filter type is chosen, the current high pass and low pass fre-

quencies are shown in the adjustable boxes just below.

To prevent over-stress of speakers by sending frequencies lower than they are physically able to handle, use the subsonic filter. For most inwall speakers, we recommend a setting of 40 Hz or higher. Contrary to popular thought, higher often sounds better for this low frequency filter. Similarly, to save the tweeters, be conservative with the setting of the tweeter protection filter. It could save you a service call.

As there is a plethora of power available (do not be fooled by The Director’s lightweight appearance) you can set up a 2-way crossover with a subwoofer playing the lows, and a pair of speakers paying the mids and highs. Enable the Low Pass Mode filter and bridge-mono the output from one zone for your subwoofer. It will just receive the low frequencies (in mono) and receive the combined power from both channels. Then use another zone’s channel pair in stereo with the High Pass mode selected for that zone, to power the speakers playing the mids and highs. Select the same input channel for both zones. See the system diagrams for a picture of this, or see the video on our website of our technical support engineers performing an interpretive dance.

Loudness: Select this for the zone for a low frequency boost at lower listening levels

Signal Sense: Select this, and the zone will turn on automatically when it senses a signal present at its selected input.

Once you have the EQ settings just the way you like them, you must save the settings. Please see the details on the next page.

Saving EQ memories and Import/Export:

It is important to save your Signal Processing to a memory. If you do not need to have multiple EQ memories for recall, it is still necessary for the Signal Processing to be saved should the power go out. When saving your Signal Processing, the Save function saves all 8 zones of Signal Processing. Once these are saved, you can export these settings from the configuration page for back up purposes or for making a template that can be repeatedly used.

You may save all of the information on this page by selecting "Save To Memory". All the graphic and parametric equalizer settings as well as any crossover setting will be retained in that number memory. The information saved in the memory is the information on this Signal Processing web page since the information on the other pages is saved separately.

Home Owner Tab

The home owner tab allows the customer to operate the system, once the other tabs have been locked to prevent access.

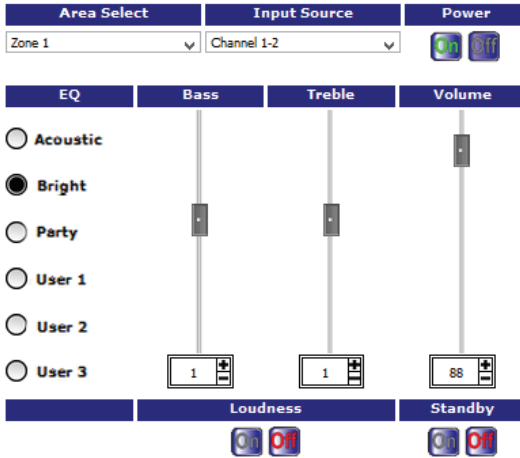

Acoustics

Magazine reviewers and audio system owners spend much time critically appraising speakers and other audio components. Unfortunately, a phenomenon that has a very large effect upon sound is not easily judged or changed. That effect is the ACOUSTICS of the environment in which you are listening.

Room acoustics is a complicated subject about which hefty textbooks have been written, and entire galaxies have gone to war over. We simply want you to be aware of a few basics that have a direct effect on real time audio analysis.

As you probably learned in high school, sound travels in waves. In an audio system, these waves are created by the speakers. Like waves in a pond created by a splash, sound waves emanate from the transducers (speakers) and spread out into the room. If your room were infinitely big, that's all there would be to it. But just as waves in a pond reach the bank and reflect back, sound waves bounce off walls, ceilings, and floors, reflecting, reinforcing and canceling each other as shown here:

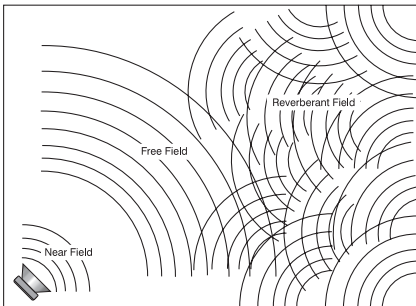

Since sound is energy, the way it reflects depends upon the angle of the surface, the type of material and the frequency of the sound wave. Because your listening position is likely to be towards the back of the Free Field (waves shown in the diagram), you also get part of the reflected Reverberant Field as well.

Now we add the next set of complications: Different frequencies of sound have different wave lengths (a function of frequency and the speed of sound). Each frequency's wavelength contributes differently to the Free and Reverberant Fields because they are different sizes. For example, a 32 Hz bass note has a wavelength of 35 feet, while a 16,000 Hz note has a wavelength just under a tenth of an inch. Tiny treble waves can be caught and neutralized by draperies, carpeting, upholstered furniture and gangs of indolent Persian cats...while gigantic bass waves simply slosh back and forth in the room.

Another set of variables is the shape and volume of your listening room. Large rooms require more bass energy to excite waves within them. Small rooms need less energy, but reflect it differently. And then there's the fact that most rooms don't have four walls anymore, but open into dining rooms, lofts, cathedral ceilings, etc. All of this means that predicting sound interaction patterns is very difficult due to the irregularities of the room shape.

As you can see, room acoustics is an important but complicated subject. To learn more about room acoustics, get a copy of AudioControl's Technical Paper 107, "Small Room Acoustics De-Mythologized". You can download this paper from www.audiocontrol.com (search "De-mythologized") or if you're still into the printed page, call us and we'll mail you a copy. The overall point that we're trying to make is that the various rooms in a home function as gigantic mechanical equalizers, boosting or cutting certain frequencies depending on size, shape, volume, acoustic treatment and the position of the speakers.

THE DIRECTOR™

Model M6400, M6800

Installation Manual

Benefits of Equalization

Rarely is the room and room decor designed to get the most out of the audio system. In fact, almost always the opposite is the case where the speaker positions and sizes are dictated by some factors which are actually contrary to good sound. This real world situation is where equalization can provide great benefits.

Speaker positions, furniture, and general room layouts may cause peaks in the frequency response. Fortunately these peaks can be tamed by judicious equalization. Also, it may be that the client has specific tastes, such as being the most interested in hearing voices such as cricket broadcasts, and you can tailor the sound to these tastes. Remember there are memories in The Director M6400 and M6800, and you could use different settings via the memories for different sources.

At all times, though, the laws of physics are hard to violate, although we do try our best. Equalization cannot make terrible acoustics sound terrific, only better. If the room has a tile floor and glass walls for example, the best case results will still be pretty bad by most measures. Further, while equalization can do wonders to help a less than perfect speaker, nothing will make a mediocre speaker sound fabulous. In other words, for best results, start with good speakers and reasonable room acoustics, if possible.

Note: *For the absolutely best results, the equalizer controls on The Director M6400 or M6800 should be adjusted with a real time analyzer such as the Audio-Control Industrial SA-4100i. Visit www.audiocontrolindustrial.com for more analysis products.*

Equalizing the System

Before proceeding with equalizing the system, it is a good idea to make sure everything is connected and working properly. You know how to check connections, and here are some reminders specific to The Director M6400 and M6800, as well as the steps to equalize.

1. Turn on the system. The Power light on the left front panel should be blue .
2. Connect to this specific Director unit over the network by entering its unique IP address into a browser (Firefox, Safari, Chrome are preferred).
3. Make sure the unit is turned on and turn off signal sense in the Operation page on the browser. On the front panel all zone status lights should start red and then turn to blue.
4. If any are not blue, check the Operation page to see if you need to unmute any zones.
5. Play pink noise through the system into the zones you are going to adjust. If needed, there is a pink noise audio file at www.audiocontrol.com. Search for "pink noise". The signal is playing through The Director unit when the LED's level meter on front panel responds to the volume.
6. Assuming you have wireless network access, now grab your trusty real time analyzer (RTA) and go into the zone you wish to adjust.
7. Place the microphone in the middle of the area of listening at the height of the typical listeners head.
8. In general, use the equalizer controls to lower peaks in the frequency response first. Peaks obscure the surrounding sounds and lowering the peaks will unleash overshadowed sounds. There is more information in the next section on equalization and

AudioControl has factory training, called Train in the Rain where we explore this subject in depth.

You can save different settings to different memories and see which one the clients like. Their taste may be different than yours.

Parametric and Graphic Equalization

The graphic equalization controls in The Director M6400 and M6800 are selected to correspond with the characteristics of wall and ceiling speakers, and as such are very effective. Graphic controls are the easiest to tune and provide a “graphic” representation of what the adjustments are. Parametric equalization requires selecting the frequency, the bandwidth of the control, as well as the level of adjustment, not an easy task to get correct. In general, parametric equalization is valuable for very large areas of change or very narrow areas.

Parametric equalization in The Director M6400 and M6800 is most likely best used for taming very narrow peaks. Do not use for very narrow dips as these dips are likely caused by cancellations and will not respond to equalization boost.

Here is an introduction to each of the graphic control frequencies and what their affect is on music.

45 Hz — Low bass. This is about the lowest frequency which in-wall, extension and small bookshelf speakers can achieve. Boosting it too far might cause problems, even though The Director M6400’s subsonic filter cuts frequencies below your adjustment point. But if your speakers can take it, a mild boost will enhance bass instruments such as Fender bass, kick drum, floor toms, timpani and double bass viols.

150 Hz — High bass. There’s a lot of bass information at this frequency. In fact, most modern music is mixed to enhance this area of the frequency spectrum. 150Hz also determines the depth of male vocals and contains reverberant information which contributes to the spaciousness of sound. Boosting 150Hz can add “POW!” and impact to bass or it can make the sound “bonky” and “boomy”. This is a critical adjustment with small or in-wall speakers. Experiment with it.

300 Hz and 700 Hz — High and low mid-range. These controls directly affect the sound of instruments and vocals. These bands also determine the speaker’s presence (whether the music sounds far away or close in). Small speakers often produce too much mid-range, so these controls can be turned down slightly during your initial experimentation. Consider reducing 700Hz if you are only using your extension speakers for background music.

2500 Hz — Treble. Female vocals and the “edge” of instruments such as guitars, snare drums, saxes, violins, etc. are found in this range. If accentuated too much (by boosting this control) sounds in the 2500Hz range can seem harsh and fatiguing to the ear due to excessive output by the speaker or because of live, reflective room acoustics.

12 kHz — High treble. The fine detail, texture and sheen of music is found here. The breathiness of vocals, the “sheen” of cymbals, the high overtones of piano and strings. Actually, there’s audible music information up to 20,000Hz on some CDs and most adult’s hearing is still pretty good at 15,000Hz. We’ve chosen 12,000Hz because it provides more useful control to compensate for room acoustics and common small-speaker deficiencies.

THE DIRECTOR™

Model M6400, M6800

Installation Manual

Subsonic and Tweeter Protection Filters

The Subsonic (aka High Pass) filter and Tweeter Protection (aka Low Pass) filter are adjusted on the signal processing web page along with equalization. Their function is simply to make the speakers sound better, play louder, and last longer.

All speakers have frequency response limitations. For the best performance, we want to operate speakers in their linear zone, that is the frequencies where their sound reproduction is not compromised by mechanical limitations.

If you do operate speakers near or at their mechanical limits, sound is compromised and parts of the speakers are stressed and, in some cases, heat up shortening its life. In other words, both the tweeter protection and subsonic filter are very important tools. Experiment with higher subsonic filters, and lower tweeter protection settings, than you might think from the published specifications of the speaker. If you do these experiments with higher/lower settings, most likely, you will find the system actually sounds much better than pushing the frequency limits. For sure the speaker will be less stressed and last longer.

Presets

On The Director M6400 and M6800, there are six memories if you wish to have different configurations. Those memories are saved on the Signal Processing tab. When saving a memory, you are saving all the signal processing page settings (equalization and filters).

Advanced Discussions

In Wall Volume Controls

What happens to the in-wall volume control if the amplifier power is greater than it can handle?

It will not be pretty but then again no one will die. Typically, the magnetics of the volume control will be over taxed, saturate and thereby become a lower impedance than rated. This will encourage The Director amplifier to put out even more power possibly putting the amp into protection. If not this extreme, there is an excellent chance the volume control saturation will damage the sound quality. The upshot is use a volume control with a margin of safety.

Installation of multiple units

Can you stack units of The Director M6400 and M6800 on top of each other without an air space in between?

You can stack a maximum of 4 units on top of one another, and allow a free rack space above and below.

Ideally, 2 units can be stacked with a free space above and below, as this will improve the ventilation to the units.

May you daisy chain or y-cord audio and power trigger connections?

Daisy chaining audio is easy as there are Loop output jacks, which can be used to drive the next amplifier.

For power control, it is easiest to have an Ethernet connection to each unit. The 12 volt mini jacks are powered to turn on another unit when the main unit is on (not standby). If you need more than 15 milliamps current on the 12 volt output, use a relay to prevent over loading The Director. (The Director itself only takes 1 milliamp to turn on.)

What are the power requirements and BTU outputs of The Director?

More detailed information is shown in the specifications section. In general, we feel a conservative, real life design criteria is 1/8th power. This will be a quite loud listening level for most rooms and assumes all zones driven at the same time. You will be amazed at how cool The Director is at this level. One rule does not fit all situations, so apply your knowledge of the particular circumstances involved. Also, see the section below on unique rooms and SPL.

How many units may I put on one 15 amp breaker?

It depends. Since you are limited to 1500 watts per device by most codes, there should be a separate 15 amp circuit for each unit.

The circumstances where The Director M6400 or M6800 draws maximum power are very rare outside of an engineering lab. Maximum power is using a sine wave input which has at least a third higher energy density than music. This would mean that all channels are operating at maximum, an unlikely situation even during a really fun party. Even more unlikely is all channels on multiple units operating at full output.

You know the system better than we do, so it is your decision. If the only use is background music, then the one-eighth power in the specifications is a reasonable (actually conservative) power draw. Of course, you will want to include a margin of safety for unusual circumstances. And in the final analysis, you have to do what the electrical inspector tells you to do.

THE DIRECTOR™

Model M6400, M6800

Installation Manual

What should I use the “Trim” controls in the browser for?

The Trim controls are an easy-to-access level setting control which you can use while in the zone. The Trim controls allow minor not major adjustments.

Unique Rooms and SPL in Large Areas

Are there any special considerations for bathrooms?

Bathrooms are irregular rooms, rooms within a room, with high ambient background noise, often with noise masking type of ambient sound, highly reflective, and often fairly large. If you pause and think about that for a moment, these are some of the more challenging rooms.

Commercial noise masking systems rely on “white noise” which sounds remarkably like a bathroom exhaust fan and like the sound of water in a shower—both of which are louder than the background noise level in the other parts of the house. So if the client wants to rock out in the bathroom, and particularly the shower, you need to have speakers very near to them. Modern day larger bathrooms need more than two speakers for these reasons.

What about large rooms as well as rooms where the listener is far from the speakers?

Typical in-wall speakers are designed to be near the listener. In common rooms with eight foot ceilings and other usual dimensions, in-wall speakers typically are not much more than eight feet from the listener. In large mansions, the game changes. Twenty foot ceilings are normal and typical speakers are too far away to provide the client much SPL (sound pressure level). There are in-wall speakers designed for these longer “throw” distances. In general, larger rooms with more height require more speakers and speakers with tighter “directivity” to get party-level SPL. In this case, also, size matters and bigger speakers are better.

Do you bite your thumb at us Sir?

I do bite my thumb sir.

Troubleshooting

Many problems can be eliminated by re-checking the wiring and settings of the unit. If a problem cannot be solved using the guide below, please call the AudioControl team for further assistance, or e-mail us at sound.great@audiocontrol.com

1. **No Sound**
 - a. Verify the Power LED is Blue.
 - b. Verify Protection LED is Off.
 - c. Verify Zone Status LED is Blue.
 - d. Verify that the correct input has been selected in the web server menus
 - e. Verify the source unit is operating.
 - f. Check the speaker connector plugs on the rear panel are secure.
 - g. Unplug the power cord and check the AC Power Fuse on the rear panel.
2. **Protection LED is off, but none of the Zone Status LEDs are on:**
 - a. Defeat the signal-sense circuits using the signal sense switch on the web server Operation tab. All of the zone status LEDs should turn on. If they do not, call AudioControl's customer service.
 - b. Verify the source unit is operating.
 - c. Increase the preamp volume if signal sense is engaged, or just going steady.
3. **Channel Status LED is Red:**
 - a. Check speaker leads for a short. Swap speaker connectors on rear to see if the problem moves with the wires.
 - b. If the unit is excessively hot, turn down the volume and allow it to cool off. The protection LED should turn off after a short while. Verify that any ventilation holes have not become blocked.
 - c. The speaker impedance may be too low. Use an ohmmeter to measure the impedance on the speaker wires.
4. **Speaker channels are cutting in and out:**
 - a. If using external volume controls, check that they can handle the power output.
 - b. Make sure the speaker impedance is not less than 4 Ohms, or 8 Ohms when used in bridged mono.
 - c. There may be a short in the wires. Suspect a short if the problem happens only at the highest volumes.
5. **Protection LED is Red:**
 - a. Disconnect power from the unit for 3 to 4 minutes and reconnect to power.
 - b. Disconnect all speaker wires. If it still turns red, and the unit has cooled, something rather serious has happened inside the unit. Call AudioControl's lonely folks in customer service.

THE DIRECTOR™

Model M6400, M6800

Installation Manual

6. Speaker Buzzing or Crackling at high volume:

- a. Reduce any preamplifier/equalizer low-frequency boost.
- b. Turn off your “Sounds of the Pacific Northwest” chainsaw and bacon-frying CD.

7. There is no audio input signal, but the Zone Status LEDs are still blue:

- a. Check the signal-sense switches in the unit’s web server tabs. If they are not engaged, the zone status LEDs will stay on as long as the master trigger is enabled.
- b. The zone status LEDs stays on for 2 minutes (depending on music volume) after the audio signal has stopped. This delay helps prevent prematurely muting during quiet passages or song changes.

8. The unit is on but you cannot trigger it off

- The unit will stay on if either the 12v master trigger is on, or jumpered on.

9. Is an in-wall volume control rated at 60 Watts (continuous) adequate?

- Just barely is the simple answer. Go for one with a higher rating if you want a reliable long-lasting system. Though the Director M6400 is rated at 65 Watts, it is a conservative number, and it can put out more power if only a few channels are driven. In contrast to the conservative rating of the Director M6400, the wall volume control may be rated using favorable assumptions. Also make sure the volume control power rating is continuous not peak. The continuous rating is about one-third of peak.

10. The Director M6400 looks like this:



- a. It has been installed upside down.
- b. You are trying a new Yoga position.

Block Diagram

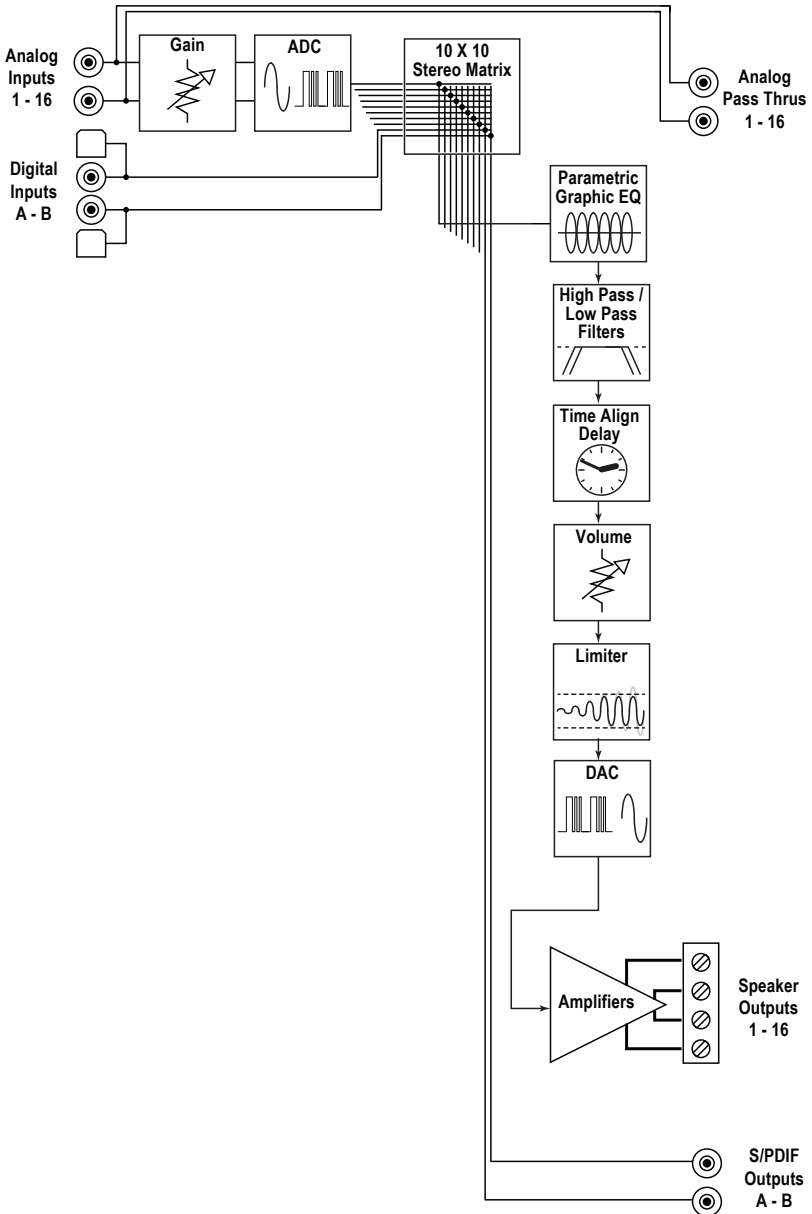

THE DIRECTOR™

Model M6400, M6800

Installation Manual

M6400 Specifications

Output Power

Per Channel 65 Watts @ 8 Ohm, 100 Watts @ 4 Ohm

Bridged Mono..... 175 Watts @ 8 Ohm

Signal to Noise Ratio > 95 (A wtd, ref full output)

Crosstalk > 80 dB @ 1 kHz

Damping Factor > 200

Gain 27 dB

Analog Input Sensitivity 1 Vrms for full output, level at maximum

DAC Specifications 32 – 96 kHz sample rate, 16/24 bit depth

AC Power Requirements

Standby <2 Watts

Idle 35 Watts

1/8th power (loud listening level) 220 Watts

Full Power..... 1300 Watts

BTU/hr Output

Standby 6.8 BTU/hr

Idle 121 BTU/hr

1/8 power (loud listening level) 314 BTU/hr

Full Power..... 890 BTU/hr

Dimensions

Height 3.5" (2U)

Width (ears on) 19.0"

Width (ears off)..... 17.0"

Depth 15.5"

Weight..... 16 lbs

Network Settings

Default IP Address **192.168.0.249**

M6800 Specifications

Output Power

Per Channel 100 Watts @ 8 Ohm, 200 Watts @ 4 Ohm

Bridged Mono..... 400 Watts @ 8 Ohm

Signal to Noise Ratio > 95 (A wtd, ref full output)

Crosstalk > 80 dB @ 1 kHz

Damping Factor > 300

Gain 30 dB

Analog Input Sensitivity 1 Vrms for full output, level at maximum

DAC Specifications 32 – 96 kHz sample rate, 16/24 bit depth

AC Power Requirements

Standby <2 Watts

Idle 53 Watts

1/8th power (loud listening level) 330 Watts

Full Power (20 A residential service limited) 2400 Watts

BTU/hr Output

Standby 6.8 BTU/hr

Idle 180 BTU/hr

1/8 power (loud listening level) 460 BTU/hr

Full Power 2124 BTU/hr

Dimensions

Height 3.5" (2U)

Width (ears on) 19.0"

Width (ears off) 17.0"

Depth 15.5"

Weight 21 lbs

Network Settings

Default IP Address **192.168.0.249**

Please note: Because of AudioControl's bold and daring quest to push back the frontiers of audio perfection, all specifications are subject to change without notice, and at any time, including (and not limited to) lunchtime, teatime, or when our engineers run around the factory shouting "Eureka!"

THE DIRECTOR™

Model M6400, M6800

Installation Manual

What to do if you need service

First, if you need service, it is probably best to go and see a trained health care professional.

If the Director M6400 or M6800 needs service, then please contact AudioControl, either by e-mail or phone. We will verify if there is anything wrong in the system that you can correct yourself, or if it needs to be sent back to our factory for repair.

Please include the following items when returning the unit:

1. A copy of your proof of purchase. No originals please. We cannot guarantee returning them to you.
2. A brief explanation of the trouble you are having with the unit. (You'd be surprised how many people forget this.) If you can supply a really detailed description of the problem, this would be so much better, and our service technicians may add you to their Christmas Card list. Please include any notes about the system and other components you are using. Is it an intermittent problem that only occurs on the first full moon of Spring?
3. A return street address. (No PO Boxes, please).
4. A daytime phone number in case our technicians have a question about the problem you are having, or if they are just feeling lonely.

5. Package the unit in the original packaging if you still have it, and if the cat hasn't had three litters of kittens in the box. Use great care and plenty of good packing materials to protect the unit and prevent it from moving about inside the box. Do not use loose materials like packing peanuts or real peanuts.

You are responsible for the freight charges to us, but we'll pay the return freight back as long as the unit is under warranty. We match whatever shipping method you use to send it to us, so if you return the unit overnight freight, we send it back overnight. We recommend United Parcel Service (UPS) for most shipments.

Repair service is available at:

Attention: Service Department

22410 70th Avenue West,

Mountlake Terrace,

WA 98043 USA

Phone 425-775-8461

FAX 425-778-3166

e-mail: sound.great@audiocontrol.com

The Warranty

In just the same way as being covered in honey and thrown into a dark pit full of hungry woodchucks, people are scared of warranties. Lots of fine print. Months of waiting around. Well, fear no more. This warranty is designed to make you rave about AudioControl. It's a warranty that looks out for you and your client, plus helps you resist the temptation to have your friend Sparky, who's "good with electronics," try to repair your AudioControl product. So go ahead, read this warranty, then register the information at www.audiocontrol.com/product-registration and include your comments.

Our warranty has conditional conditions! "Conditional" doesn't mean anything ominous. The Federal Trade Commission tells all manufacturers to use the term to indicate that certain conditions have to be met before they'll honor the warranty. If you meet all of these conditions, AudioControl will, at its discretion, repair or replace any AudioControl products that exhibit defects in materials and/or workmanship during the warranty on your product for five (5) years from the date you bought it, and we will fix or replace it, at our option, during that time.

Here are the conditional conditions:

1. You must fully register your purchase within 15 days of the purchase date by going to the AudioControl product registration page at www.audiocontrol.com/product-registration. Failure to register your product will negate the warranty.
2. You need to hold on to your sales receipt! All warranty service requires original sales receipt documentation. The warranty only applies to the original purchaser from an authorized AudioControl dealer. Note: Products purchased from unauthorized dealers are not covered under warranty.
3. If an authorized AudioControl dealer installs your AudioControl product, the warranty is five years, otherwise the warranty is limited to one year.
4. Our warranty covers AudioControl products that have been installed according to the instructions in the installation manual.
5. You cannot let anybody who isn't: (A) the AudioControl factory; or (B) somebody authorized in writing by AudioControl service your AudioControl product. If anyone other than (A), or (B) messes with your AudioControl product, the warranty is void.
6. The warranty is void if the serial number is altered, defaced or removed, or if your product has been used improperly. Now that may sound like a big loophole, but here is what we mean by this: Unwarranted abuse is: (A) physical damage (don't use your product to level your dining room table); (B) improper connections (120 volts into the RCA jacks can fry the poor thing); (C) sadistic things! This is the best product we know how to build, but for example if you mount it to the front bumper of your car, drop it over the Niagara Falls or use it for Clay Pigeon shooting practice, something will go wrong.

Assuming you conform to 1 through 6, and it really isn't all that hard to do, we get the option of fixing your product or replacing it with a new one at our discretion.

In the event that your product is out of warranty or not covered under our warranty you may request to have any damage repaired at our normal "Out of Warranty" repair cost.

THE DIRECTOR™

Model M6400, M6800

Installation Manual

Legalese Section

This is the only warranty issued by AudioControl. This warranty gives you specific legal rights, and you may also have rights that vary from state to state. Promises of how well your AudioControl product will work are not implied by this warranty. Other than what we've said we'll do in this warranty, we have no obligation, express or implied. We make no warranty of merchantability or fitness for any particular purpose. Also neither we nor anyone else who has been involved in the development or manufacture of the unit will have any liability of any incidental, consequential, special or punitive damages, including but not limited to any lost profits or damage to other parts of your system by hooking up to the unit (whether the claim is one for breach of warranty, negligence of other tort, or any other kind of claim). Some states do not allow limitations of consequential damages.

FoxTrot Box Step

